

## Specification

Slit lamp model	HS-5000	HS-5500	HS-7000	HS-7500	
Slit illumination	Slit length(mm)	0.3~14			
	Slit width(mm)	0~14 continuous			
	Slit projection	1x	1.167x	1x	1.167x
	Filters	Cobalt blue, Red-free, Grey, Heat absorption and Yellow			
	Slit rotation	0°~180° continuous			
Patient's eye / Prism	Angle of incidence	0°, 5°, 10°, 15°, 20°	0°~20° continuous	0°, 5°, 10°, 15°, 20°	0°~20° continuous
	Surface working distance	80mm	66mm	80mm	66mm
Microscope	Microscope	5 steps			
	Type	Galilean converging binocular			
	Magnification	5 position rotating drum			
	Eyepieces	12.5x	12.5x, 10x		
	Total magnifications	6.5x, 11x, 16x, 23.2x, 39.3x	6x, 10x, 16x, 25x, 40x(12.5x) 4.6x, 8x, 12.8x, 20x, 32x(10x)		
	Real fields of view(mm)	38.5, 22.2, 15.2, 10.5, 6.1	38.5, 24, 15, 9, 6		
	Interpupillary adjustment	55mm~80mm			
	Vertical movement	30mm			
Base	Longitudinal movement	100mm			
	Lateral movement	100mm			
	Power supply	Free voltage 100-240V AC			
	Voltage frequency	50 / 60Hz			
	Power consumption	LED Type :40VA, HLG Type:107VA			
	Instrument voltage	12V DC			
	LED / Halogen bulb	LED Type:10V, 4.4W, HLG Type:12V, 30W			
	Fixation point bulb	3.4V 20mA			
	Camera model	HIS-5000U(10.0M)		HIS-5000U(5.0M)	
	Digital camera	Size(except knob)	138 x 71 x 58mm		172 x 78 x 66mm
Image sensor		1/2" CMOS		1" CMOS	
Image size		up to 3840 x 2748 pixels		up to 2592 x 2048 pixels	
Cell size		1.67µm x 1.67µm		4.65µm x 4.65µm	
Transmit method		USB 2.0		USB 3.0	
Transmit speed		480Mbps		5.0Gbps	
Frame rate		Maximum 30fps			
Lens mount		C-Mount			
Shutter		Rolling shutter		Global shutter	
Photographing		External trigger or Software trigger			
Power consumption		5V DC, 2.5W		5V DC, 3.5W	
System requirements	CPU	Intel® Core™ i3(2.4GHz over)		Intel® Core™ i5(3.4GHz over)	
	Memory	Over 2GB recommended		Over 4GB recommended	
	Video card	On board graphics chip (PCI/PCIe graphics card with DirectDraw support DirectX 9.0 or Higher Recommended)			
	System	Microsoft® Windows® 7 SP1, Windows® 8, Windows® 10			
	Monitor	Resolution 1920 x 1080 Recommended			

Option : PC, Table Designs and details can be changed without prior notice for the purposes of improvement.

# Huvitz

HUVITZ Co., Ltd. 38, Burim-ro 170 beon-gil, Dongan-gu,  
Anyang-si, Gyeonggi-do, 14055, Republic of Korea  
Tel:+82-31-428-9100 Fax:+82-31-477-8617 <http://www.huvitz.com>

JOARAA-16-00001(Rev.G)



Innovative  
Ophthalmology  
Solutions

## Huvitz Slit Lamp & Imaging System

**Huvitz** Re:define. Re:create

Advanced optic system, a remarkable difference.

The industry-leading manufacturer, Huvitz, presents a high quality, world-class optic system applied slit lamp series manufactured based on information and experience within the market. The slit lamp is manufactured beyond the industry standard.

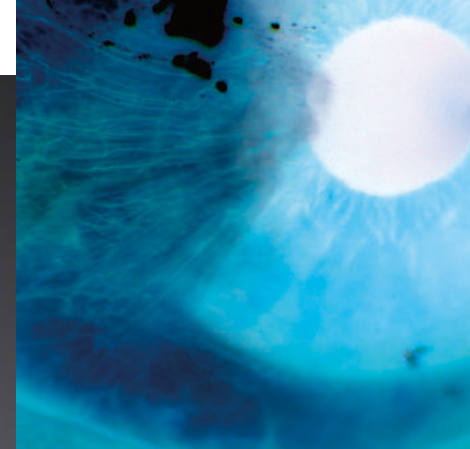

## Huvitz Slit Lamp HS-7000 / 7500



Ultra high end optic system chosen by experienced industry professionals: HS-7000 and HS-7500



### Microscope

With the global standard Galilean converging binocular type optic system, the Huvitz high end slit lamp series offers a wider angle, live image and increased accuracy.

In conclusion, this slit lamp series offers a better and more successful diagnosis. We invite you to compare our slit lamp series with the competitors analyzing color aberration; view angle and image color clarity.

- 12.5x Eye pieces -  
6x: 38.5mm, 10x: 24mm, 16x: 15mm,  
25x: 9mm, 40x: 6mm
- 10x Eye pieces (Optional) -  
5x: 38.5mm, 8x: 24mm, 12x: 15mm,  
20x: 9mm, 32x: 6mm

### Magnification Control System

The 5-position drum-style magnification changer provides a wide range of magnification from 6x to 40x easily accessible by rotating the drum.

The design of this system and the uniquely designed Huvitz optic system allows you to offer a more accurate diagnosis and observation to patients without any image distortion in any magnification level.



### Illumination

The 12-volt, 30-watt high luminance halogen lamp provides incredible clarity for both image and video.

- Optional: 10V, 4.4W LED lamp



### Integrated Control

The integrated omni style joystick is simple to control.

A trigger button is conveniently mounted on the joystick for easy image and video capture.

Images and videos can be stored simultaneously if the slit lamp is connected to image devices.



### Yellow Filter

A yellow filter is conveniently located near the ocular for effortless insertion of the fluorescein pattern.

With a control lever, any filters are easily inserted.

- Options include cobalt blue, red free, heat absorption, grey, and yellow.

### Design

The slit lamps are offered in the Tower Illumination type (HS-7000) and the Integrated Illumination type (HS-7500) slit lamp models.

Both types are designed in the industry standard type models used for their proven accuracy and reliability.

## Huvitz Slit Lamp HS-5500 / 5000



See the difference by looking through the Huvitz Slit Lamp chosen by opinion leaders in the industry: HS-5000 and HS-5500



### Microscope

HS-5000 and HS-5500 deliver crisp images and a wide field of view with the global standard Galilean Converging Binocular optical system.

- 12.5x Eye pieces -  
6x: 38.5mm, 10x: 22.2mm,  
16x: 15.2mm, 25x: 10.5mm, 40x: 6.1mm



### Magnification Control System

The 5-position drum-style magnification changer provides a wide range of magnification from 6x to 40x easily accessible by rotating the drum.

The design of this system and the uniquely designed Huvitz optic system allows you to offer a more accurate diagnosis and observation to patients without any image distortion in any magnification level.



### Integrated Control

The integrated omni style joystick is simple to control.

A trigger button is conveniently mounted on the joystick for easy image and video capture.

Images and videos can be stored simultaneously if the slit lamp is connected to image devices.



### Yellow Filter

A yellow filter is conveniently located near the ocular for effortless insertion of the fluorescein pattern.

With a control lever, any filters are easily inserted.

- Options include cobalt blue, red free, heat absorption, grey, and yellow.

### Illumination

The light source is a 12-volt, 30-watt high luminance halogen lamp that provides incredible clarity in both the Tower Illumination and Integrated Illumination type slit lamps.

- Optional: 10V, 4.4W LED lamp

### Design

The slit lamps are offered in the Tower Illumination type (HS-5000) and the Integrated Illumination type (HS-5500) slit lamp models.

Both types are designed in the industry standard type models used for their proven accuracy and reliability.

# Huvitz Imaging System HIS-5000



From diagnosis and patient data management to presentation and image processing: the complete kit of user-friendly image management system

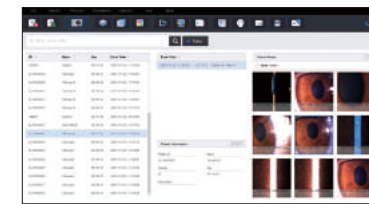

## Patient Information Management

MS Access Database system allows you to search symptoms, diagnosed information, and related contents. You can also easily manage data and history of patients.

## Intuitive User Interface

Intuitive tree-structured user interface allows easy access to update of patient information without any complicated clicking.



## Digital Camera (USB 3.0)

USB 3.0 interface ensures maximum compatibility for any computer environment and used wide 1-inch image sensor to get brighter images.

- Beam Splitter - 100:0 / 30:70 (Variable type)

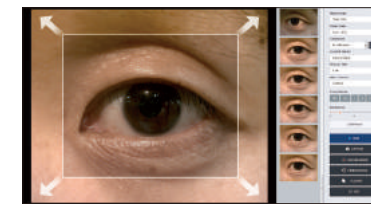

## FOV(Field of View)

It provides extended view thanks to wide-angle lens.

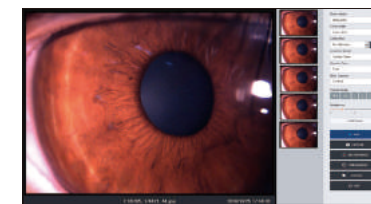

## Quick Image & Video Saving

High performance Global shutter CMOS camera provides quick image capture of diagnosed images and videos in real time with a simple click on joystick button.

## Powerful Image Processing

With Live Tool graphic library, all the images such as JPG, TIFF, RAW and other formats can be adjusted for brightness, contrast, color channel, saturation, inversion, sharpness, red-free, etc.

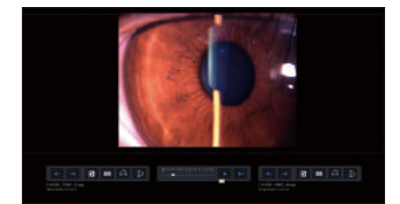

## Image Manipulation for the Best Diagnosis

### Compare

The selected images can be magnified, reduced and rotated with various graphic effects for accurate comparison and diagnosis.

### Overlay

Correlative animation of images captured in different time frames allows you to identify metastasis of symptoms.

### Slide Show

All selected images can be shown in a slide show, which can be used for presentations.

### Reference

Images of same symptoms can be registered or searched for further reference.

### Report Generation

Automatic patient report export function in MS Word format.

### Print

Easy single-click printing of current images.

### Time Machine

It shows 30 frames (images) of 2 seconds from the moment click joystick. Therefore, it provides wider choices for users to choose.

### Flicker

As it shows 30 frames (images) with different brightness of 2 seconds from the moment click joystick, users can choose images that suit their taste.

### DICOM

HIS supports DICOM connection.

Huvitz Quality, Huvitz Standard

Tens of thousands of repeated electro-mechanical tests and highest international standards ensure Huvitz slit lamps' quality and durability.



#### High Quality Standards

From the design and production process, all Huvitz product goals are made to be durable in extreme conditions.



#### Durability Achieved after Extreme Tests

All the Huvitz slit lamps' modules and joints are designed after tens of thousands of repeated operation tests to ensure long life time usage.

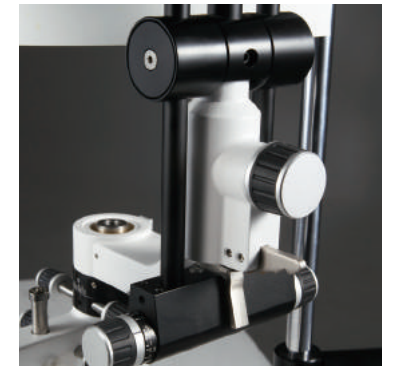

#### Smooth and Easy Precision Movement

Smooth and precise movements of all operation knobs and joystick factor into making diagnostic procedures even easier.

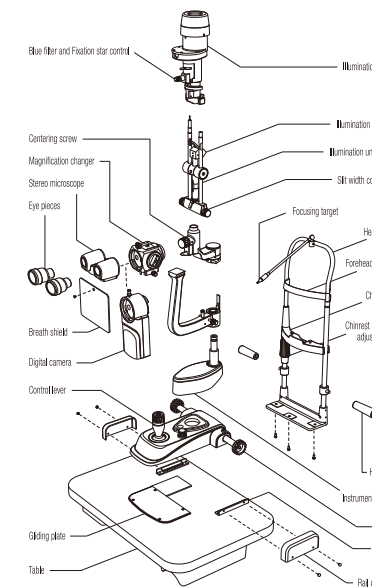

#### International Quality Assurance

All Huvitz slit lamps are certified by the international quality assurance system as symbols below indicate.

